

Concrete Accessories

Bar Ties

Available in stock sizes:

16 ga. Black Annealed
#4, #5, #5-1/2, #6, #7, #8

16 ga. PVC Coated
#5-1/2, #6, #8

5000/bundle

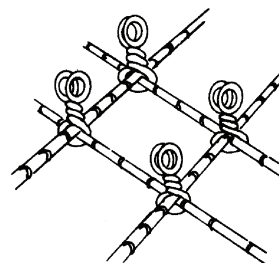
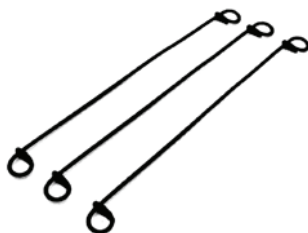

Tywire



16 ga. Black Annealed
16 ga. PVC Coated
"Gator Wire"
20 rolls/case

Tywire Reels



Tying Tools



Wire Tie Table

BAR TIE LENGTH FOR STANDARD REINFORCING BARS

Bar Nos.	2	3	4	5	6	7	8	9	10	11	
Bar Sizes	1/4"	3/8"	1/2"	5/8"	3/4"	7/8"	1"	1-1/8"	1-1/4"	1-3/8"	
Length in inches of Tie Required											
2	1/4	3	3-1/2	4	4-1/2	5	5-1/2	6	6	6-1/2	7
3	3/8	3-1/2	4	4-1/2	5	5-1/2	6	6-1/2	6-1/2	7	7-1/2
4	1/2	4	4-1/2	5	5	5-1/2	6	6-1/2	7	7-1/2	8
5	5/8	4-1/2	5	5	5-1/2	6	6-1/2	7	7	7-1/2	8
6	3/4	5	5-1/2	5-1/2	6	6-1/2	6-1/2	7-1/2	7-1/2	8	8-1/2
7	7/8	5-1/2	6	6	6-1/2	6-1/2	7	7-1/2	8	8-1/2	8-1/2
8	1	6	6-1/2	6-1/2	7	7-1/2	7-1/2	8	8-1/2	9	9
9	1-1/8	6	6-1/2	7	7	7-1/2	8	8-1/2	8-1/2	9	9
10	1-1/4	6-1/2	7	7-1/2	7-1/2	8	8-1/2	9	9	9	10
11	1-3/8	7	7-1/2	8	8	8-1/2	8-1/2	9	9	10	10

Annealed Wire



Available in stock sizes: #9, #11, #12

Division 3

Concrete Accessories

Dovetail Anchor Slot

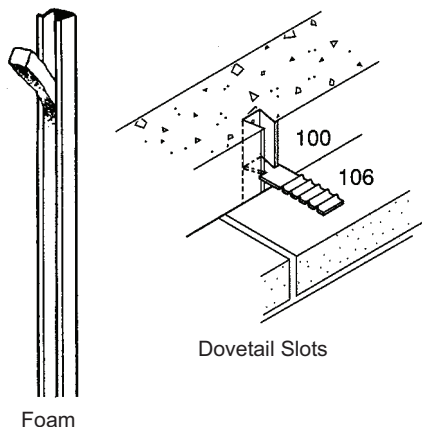

Standard Dovetail Slot. 1" wide x 1" deep x 5/8" throat, 26, 24 or 22 gauge mill galvanized steel. 26 gauge stainless steel. Use with standard 1" wide dovetail anchors.

Wedge Inserts

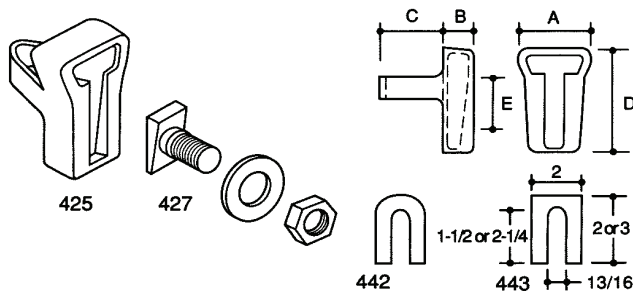

Wedge Inserts 425

No.	Bolt Dia.	Dim. In.				
		A	B	C	D	E ¹
425.5	5/8	2-1/4	1-1/32	1-15/16	3-5/8	1-5/8
425.6	3/4	2-5/16	1-3/16	2-1/2	3-7/8	1-3/4
425.6L ²	3/4	2-1/4	1-1/4	2-3/8	5-1/2	3

Askew Head Bolts 427

No.	Bolt Dia.	Available Lengths ³
427.5	5/8	1-1/2, 2, 2-1/2, 3
427.6	3/4	1-1/2, 2, 2-1/2, 3, 3-1/2

- "E" is length of vertical adjustment for Askew Head Bolts.
- Long Inserts provide greater adjustability and can be placed near bottom of concrete beams. Anchor loops are 3-1/2" above bottom of Insert and can be secured to bottom layer of beam reinforcing.
- Bolt extends beyond face of Insert approx. 1/4" less than specified length.

Reglets

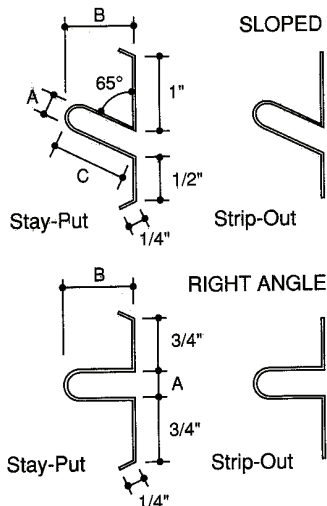
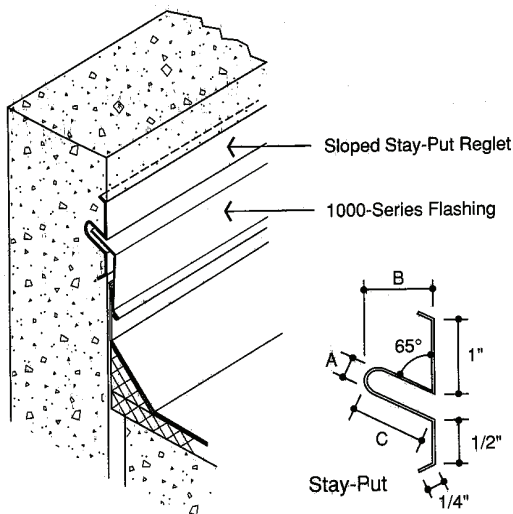

Materials: 26 gauge mill galvanized steel is standard. Stay-Put Reglets are also fabricated in 26 gauge stainless steel and 16-oz. copper. Do not use Reglets with dissimilar metal flashings if potential for galvanic corrosion exists.

F-100 Cushion-Lock® Reglet

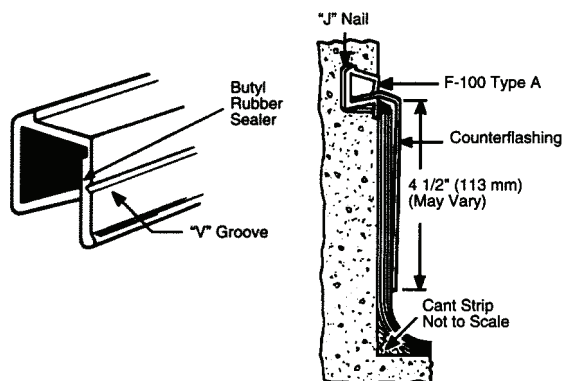

- PVC plastic is inert – no reaction with concrete, concrete additives or any metal.
- Comes prefilled with butyl rubber sealer.
- No concrete can ever enter reglet.
- Safe, rapid installation of reglet and counterflashing in all kinds of weather.
- No exposed nails or reglet surfaces.
- **Note:** Not recommended for use on top of parapet walls as roof leaks may occur.

Concrete Accessories

Polyethylene Hoppers



37" square

Discharge Size: 6" - 8" - 12"
Lightweight 20 lbs

Elephant Trunk From PVC

50' roll lengths
8" & 12" diameters

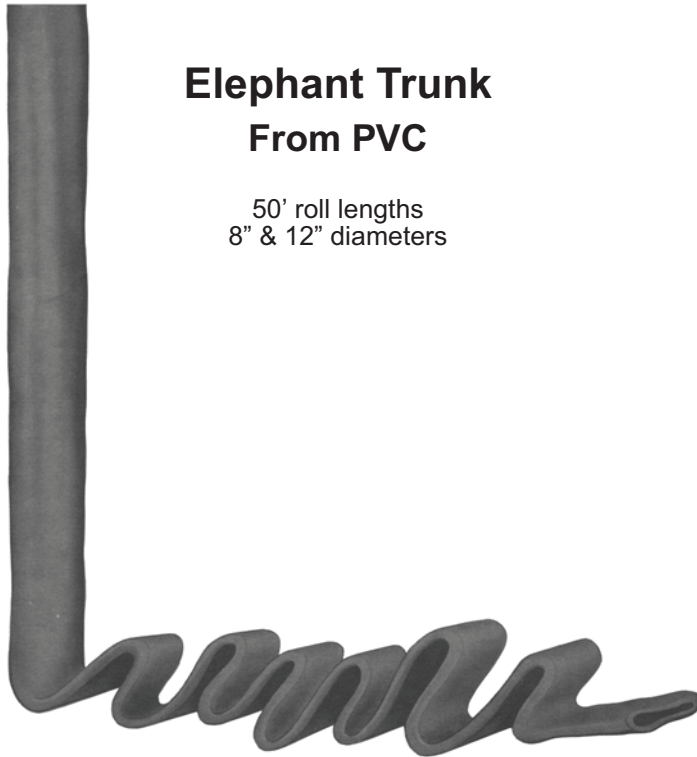

Polyethylene Tremie Pipe



4' lengths

9" to 8" diameter
13" to 12" diameter

Steel Collar

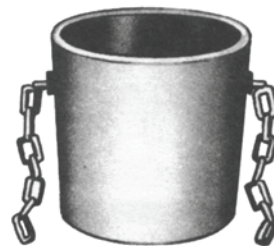

Steel Clamp



Test Cylinders



- 6" I.D. x 12" Long
- Test cylinder mold is non-absorptive
- Molded single unit for consistent dimensional uniformity
- Top rim eliminates deformation
- Smooth molded plastic allows quick, easy stripping
- Strong, durable

Concrete Accessories



Each Dreyer vibrator is designed to maintain a minimum of 10,000 VPM in low slump concrete. Select your Dreyer vibrator by motor size, shaft length and head diameter to fit your job requirements, and know you've got the performance leader.

At Dreyer, concrete vibration is not a side line, it's our specialty.

• **Heavy-Duty Universal Electric Motor**
120V AC/DC

• **Aluminum Castings**
Special aluminum alloy motor frames for tough job punishment and easy cleanup.

• **Double Life Casings**
Both ends of standard casings are identical. When one end becomes worn, the casing can be reversed, doubling the service life.

• **Extension Shafts**
Require no additional bearings or special coupling devices.

• **Replaceable Steel Tips**
For applications where there is excessive tube wear. Does not expose internal bearings when replacing.

• **Shoulder Strap**
Included at no extra charge.

• **Tapered Round Heads**
Dreyer head and shaft connections are smooth with no abrupt offsets to avoid hangups.

• **Innovative Pneumatic Vibrator**
Capable of running small diameter heads with shafts that interchange with our electric units.





• **Rubber Tip Heads & Coated Heads**
Protect expensive forms and coated rebar from being damaged.

• **Factory Support**
Technical information on choosing the proper vibrator, maintenance on units to avoid downtime on the jobsite, and general operation procedures.





• **Warranty**
One year on all new Dreyer products to be free from any defects.

Dreyer shafts are available in any length, up to the maximum working length.







Model JE - 1 1/2 hp Motor Maximum Working Length - 20' Net Weight - 15 lbs. Extension Shafts J7X - 7 FOOT J10X - 10 FOOT <small>*JE shafts are interchangeable with Model BE-2 1/2 hp Motor</small>	JE Head Size Options  1 3/16"  1 1/8"  1 3/8"  1 3/4"
---	--







Model QE - 2 1/2 hp Motor Maximum Working Length - 45' Net Weight - 24 lbs. Extension Shafts Q7X - 7 FOOT Q10X - 10 FOOT Q14X - 14 FOOT	QE Head Size Options  1 3/8"  1 3/4"  2 1/8"  2 1/2"
---	---



Model BE - 2 1/2 hp Motor Maximum Working Length - 45' Net Weight - 24 lbs. *Interchanges with shafts and heads used on Model JE - 1 1/2 hp Motor	BE Head Size Options  1 3/8"  1 3/4"  2 1/8"  2 1/2"
--	---



Model RA - Pneumatic Vibrator Maximum Working Length - 20' Net Weight - 8.5 lbs. 40 CFM / 90 PSI Extension Shafts J7X - 7 FOOT J10X - 10 FOOT	RA Head Size Options  1 3/16"  1 1/8"  1 3/8"  1 3/4"
---	--

You've heard it said – "they don't make tools that last like they used to" – Dreyer still does!

Division 3

TOLL FREE 800-892-7224
800-821-7735



LOCAL 816-525-3640
FAX 816-525-4533

Concrete Winter Protection

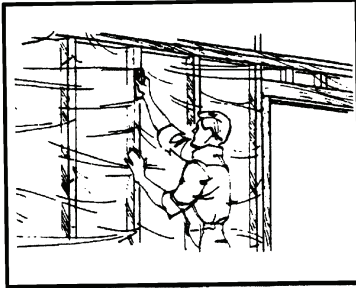

Wall Construction

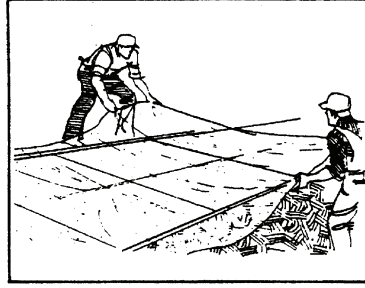

Concrete Curing

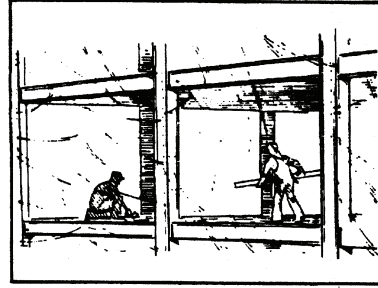

Building Enclosures



Insulated Blankets for Concrete Curing

Woven poly cover with 1/2" closed cell foam filled.

Available in stock sizes:
6' x 25'
12' x 25'

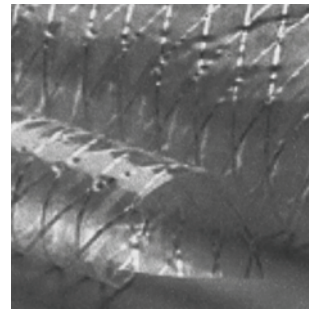

Woven Reinforced Poly

Available in stock sizes:
8' x 100' up to 40' x 100'

Also available: String reinforced poly.



Burlap

Available in stock - 10 oz.
10' x 28' and 5' x 300'
Also available: String reinforced poly.

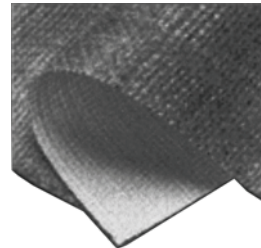

Curelap – Poly Coated Burlap

A combination of 10 oz. burlap and 5 mil white opaque poly. The 5 mil polyethylene is extruded onto the 10-ounce burlap. The result is a lightweight summer curing blanket that can be used over and over again. The burlap layer distributes the water evenly over the covered surface, while the white opaque poly reflects the intense rays of the sun.

In this way, the concrete is allowed to cure... perfectly.

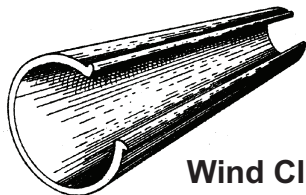

Wind Clips